

2J0A02-5.0-C151G

5.0 GHz ISM Connector Mount

Key Features

- 5.0 GHz ISM
- 4920-5925 MHz
- Connector Mount
- High Gain
- High Efficiency
- Ground Plane Dependent
- Dimensions 44 × 9.6 mm



1. Antenna and electrical specifications

Parameters	5.0 GHz ISM Antenna
Standards	WiFi, ISM
Band (MHz)	5.0 GHz
Frequency (MHz)	4920-5925
Return Loss (dB)	~-12.7
VSWR	~1.6:1
Efficiency (%)	~88
Peak Gain (dBi)	~5.3
Average Gain (dB)	~-0.5
Impedance (Ohm)	50
Polarisation	Linear
Radiation Pattern	Omni-Directional
Max. Input Power (W)	25
Connector Type	RP-SMA-Male Standard

Antenna Measurement Conditions:

Mounted on Ground Plane of 70x35 mm.

Measured in Certified CTIA 3D Anechoic Chamber

2. Mechanical and environmental specifications

Specifications	2J0A02-5.0-C151G
Mounting Type	Connector Mount
Dimensions (mm)	44 x 9.6
Radome	ABS UV Stable
Radome color	Black
Operating Temperature (C)	-40 to +85
Storage Temperature (C)	-40 to +85
Substance Compliance	RoHS

3. Antenna parameters

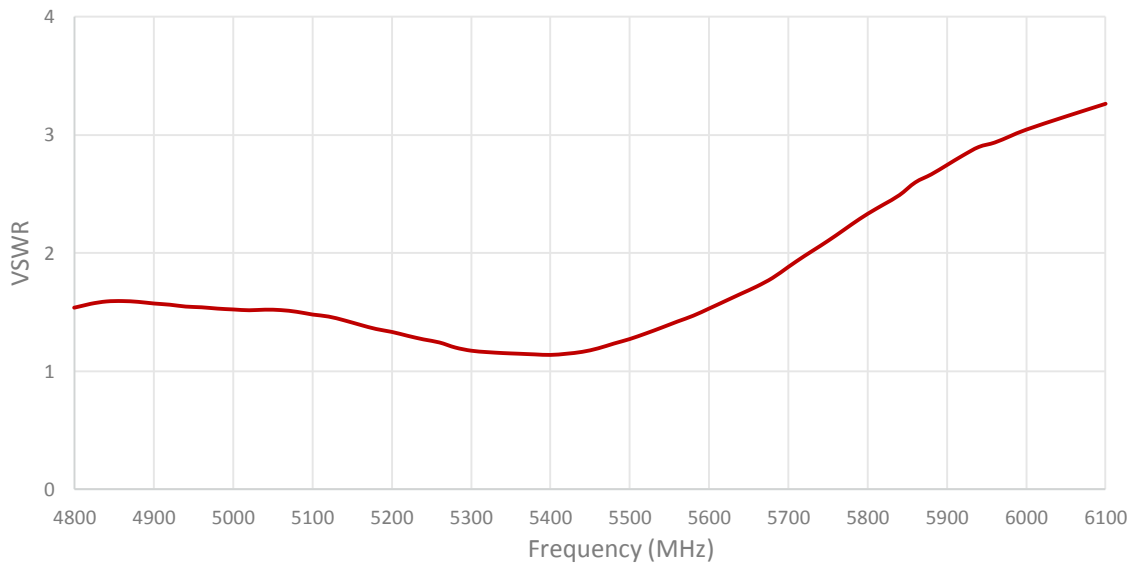
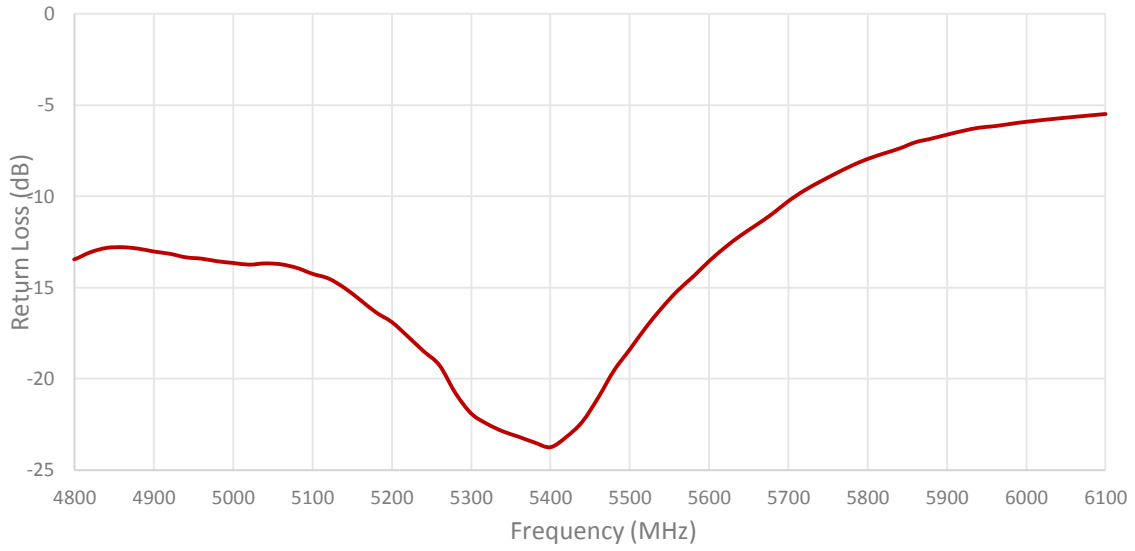

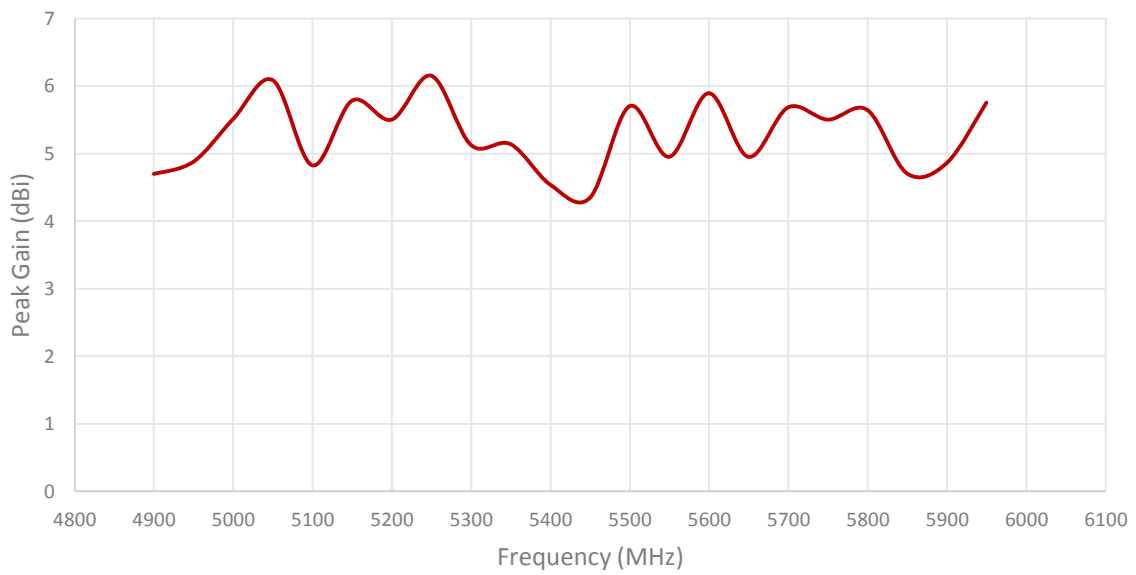
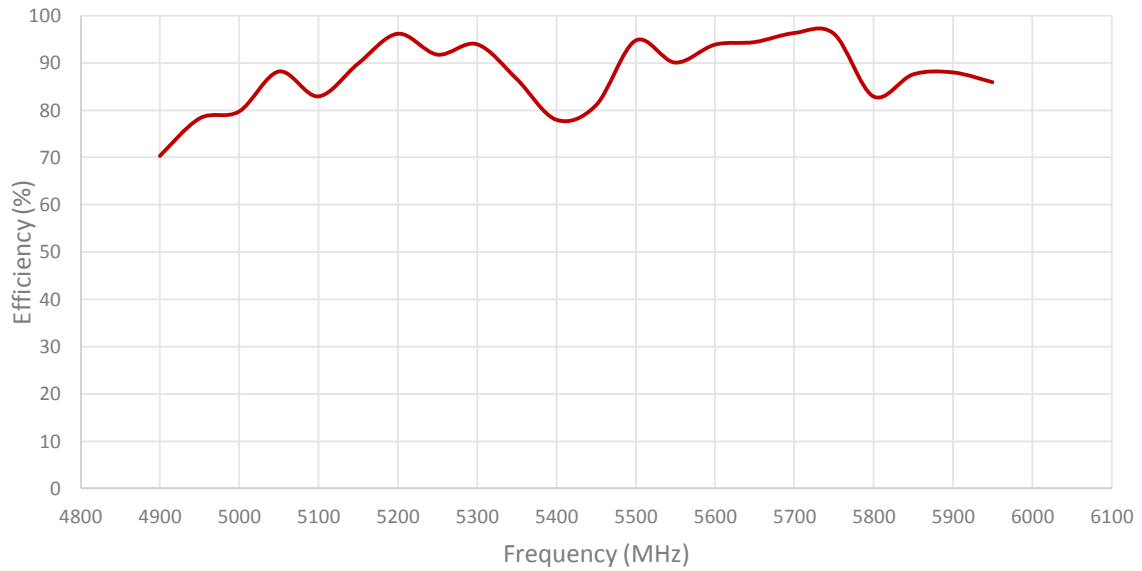

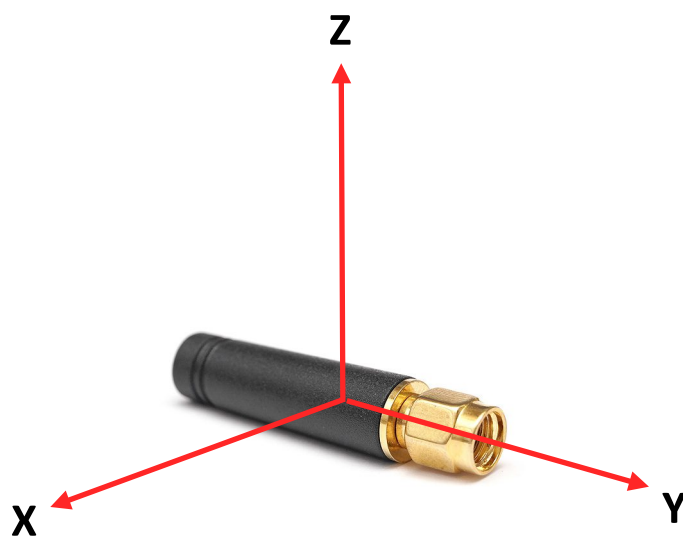
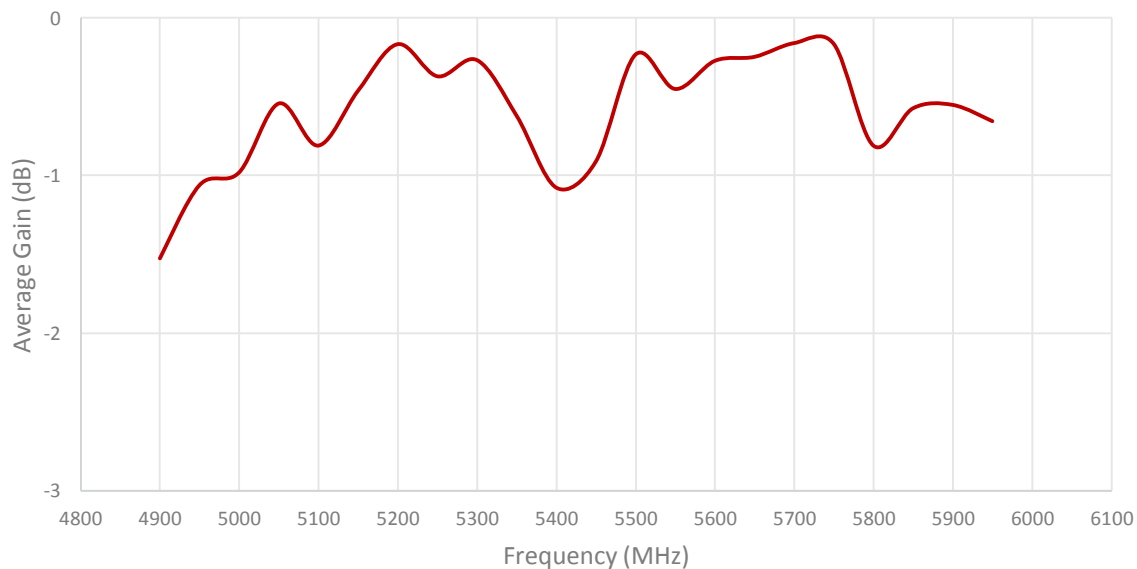

Radiation pattern reference

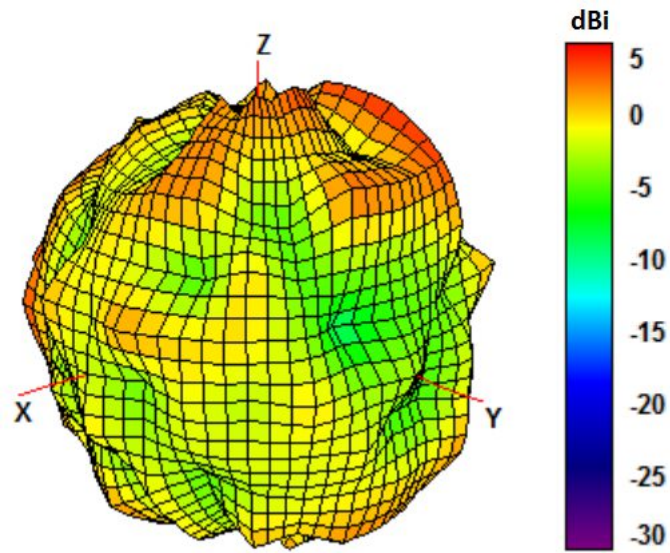

5500 MHz Radiation pattern

4. Antenna drawings

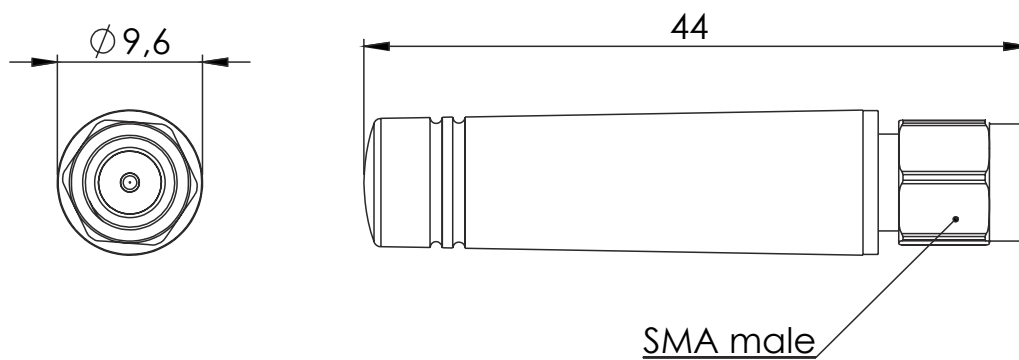

5. Antenna Images

