

2J301M (DATASHEET)

Type	Multiband Antenna
Frequencies	AMPS (824-894 MHz) GSM (900 MHz) DCS (1800 MHz) PCS (1900 MHz) 3G (UMTS 2.1 GHz)
Mounting	Magnetic Mount
Revision	00



P. Tipul



D. Noble

1. SPECIFICATION

1.1. *Electrical Specifications*

Frequencies	AMPS (824-894 MHz) GSM (900 MHz) DCS (1800 MHz) PCS (1900 MHz) 3G (UMTS 2.1 GHz)
Impedance	50 Ohms
Polarization	Linear
Gain	2.2dBi Max
VSWR	<3:1
Operating temperature	-40°C to +85°C

1.2. *Connection Specifications*

Connector type:	FME female
Cable:	RG174U
Cable length:	250 cm

For different cable length and connector type ask our sales team.

1.3. *Mechanical Specifications and Dimensions*

Material:	ABS
Max. dimensions:	30.9mm x 71.5mm (D x H)
Weight:	50g 'weight with connection above'
Colour:	Black (for different colours please ask our sales team)

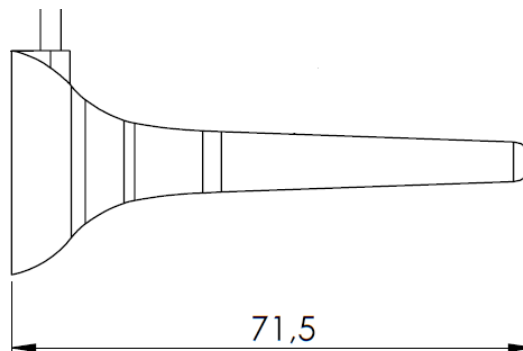
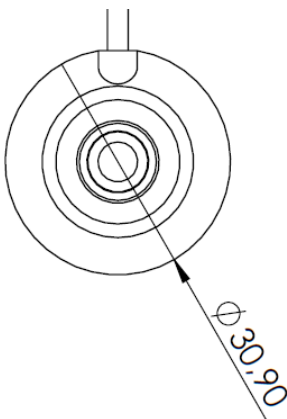

2. MEASUREMENT

2.1. S11

VSWR

Log Mag

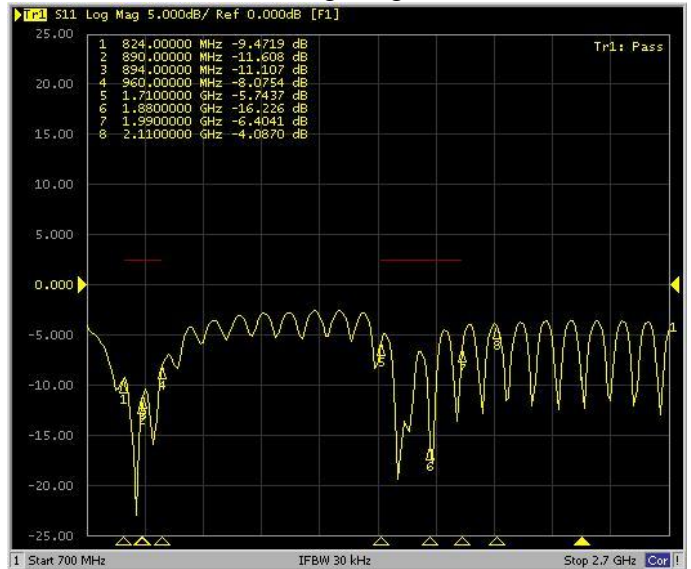
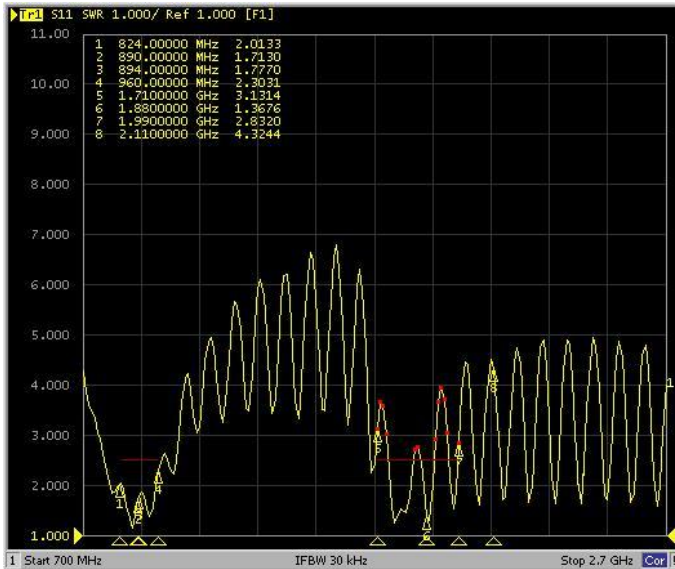

Tested with 100cm cable length - RG174 with FME female

Tested with 100cm cable length - RG174 with FME female

2.2. 3D Spherical

Freq = 0.8500GHz Az= 45 EL= 45

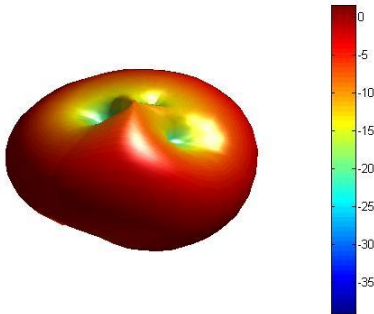

Freq = 0.9GHz Az= 45 EL= 45

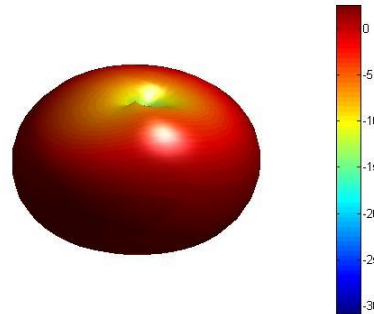

Freq = 1.8GHz Az= 45 EL= 45

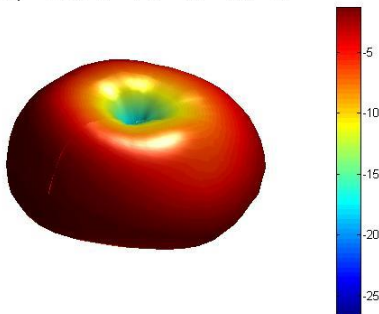

Freq = 1.9GHz Az= 45 EL= 45

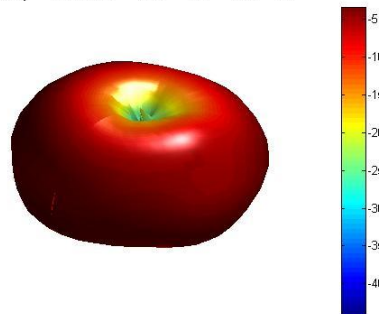

Freq = 2.1GHz Az= 45 EL= 45

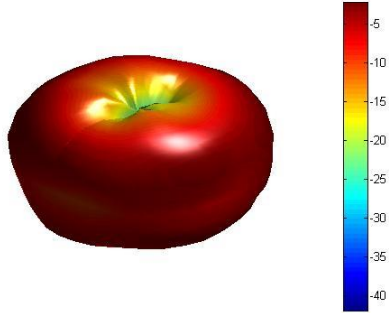

Freq = 2.4GHz Az= 45 EL= 45

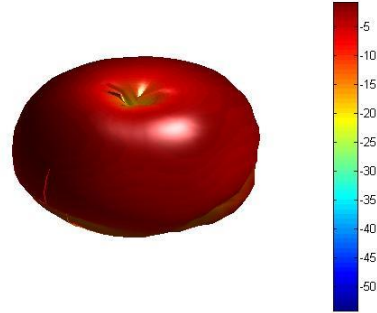

3. IMAGES

