

## 2J4824P

### Cellular/LTE Adhesive Mount

#### Key Features

##### Cable 1: CELLULAR/LTE

- 698-960 MHz
- 1710-2170 MHz
- 2500-2700 MHz

Adhesive Mount

Ground Plane Independent

Customizable Cable and Connector

Dimensions 83 x 35 x 13.3 mm



**Note:** Antenna 2J4824PR equipped with 10K resistor for antenna detection is available.



## 1. Antenna and electrical specifications

Cable 1

Parameters	CELLULAR/LTE Antenna		
<b>Standards</b>	2G, 3G and 4G LTE		
<b>Band (MHz)</b>	700/850/900	1700/1800/1900/2100	2600
<b>Frequency (MHz)</b>	698-960	1710-2170	2500-2700
<b>Return Loss (dB)</b>	~-13.1	~-16.7	~-11.6
<b>VSWR</b>	~1.9:1	~1.4:1	~1.8:1
<b>Efficiency (%)</b>	~59	~55	~31
<b>Peak Gain (dBi)</b>	~3.4	~2.1	~1.0
<b>Average Gain (dB)</b>	~-2.3	~-2.5	~-5.1
<b>Impedance (Ohm)</b>	50		
<b>Polarisation</b>	Linear		
<b>Radiation Pattern</b>	Omni-Directional		
<b>Max. Input Power (W)</b>	25		
<b>Connector Type</b>	SMA-Male Standard (Other Connectors Available)		
<b>Cable Length</b>	300 cm Standard (Any Cable Length Available)		
<b>Cable Type</b>	LMR100 Standard (Other Cables Available)		

### Antenna Measurement Conditions:

Mounted on 30 x 30 x 0.25 cm ABS Plate

200 cm of Cable LMR100

Measured in Certified CTIA 3D Anechoic Chamber

## 2. Mechanical and environmental specifications

Specifications	2J4824P
<b>Mounting Type</b>	Adhesive Mount
<b>Dimensions (mm)</b>	83 x 35 x 13.3
<b>Radome</b>	ABS
<b>Radome color</b>	Black
<b>Operating Temperature (C)</b>	-40 to +85
<b>Storage Temperature (C)</b>	-40 to +85
<b>Substance Compliance</b>	RoHS

### 3. Antenna parameters

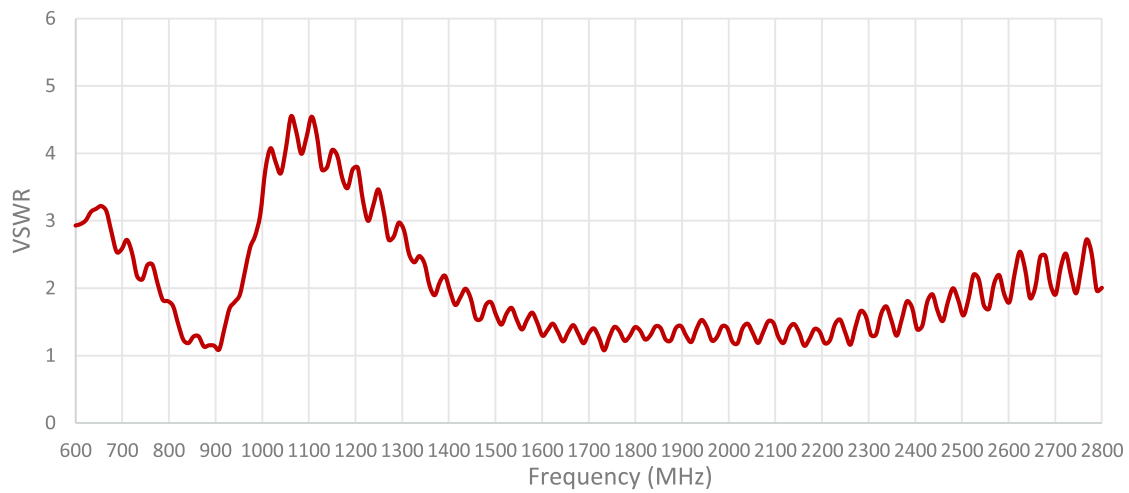
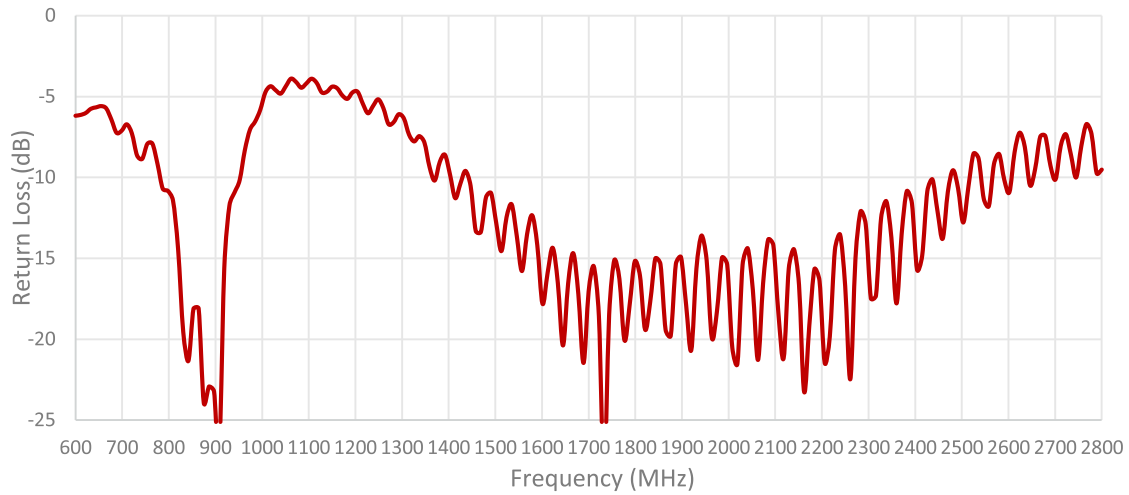

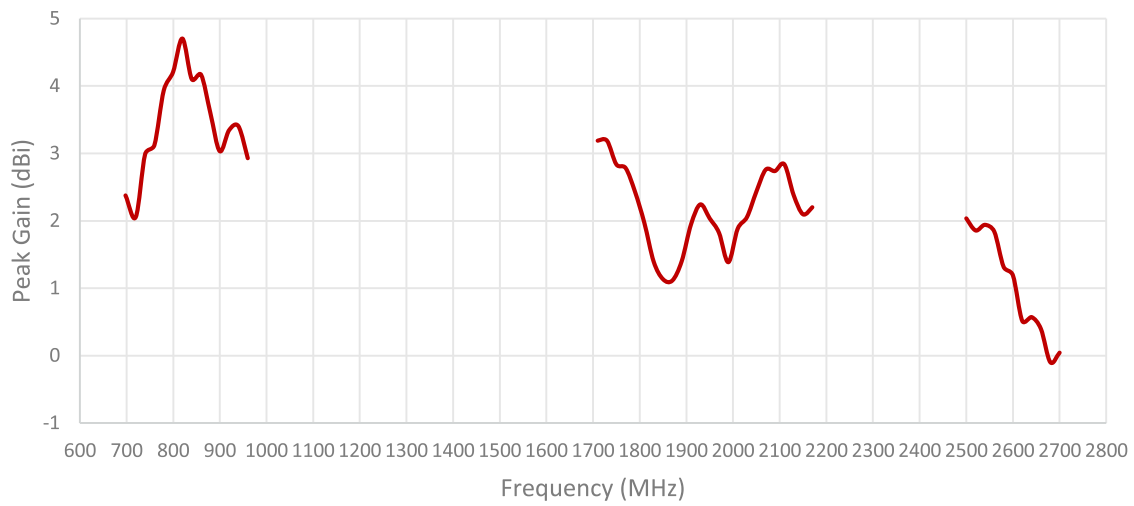
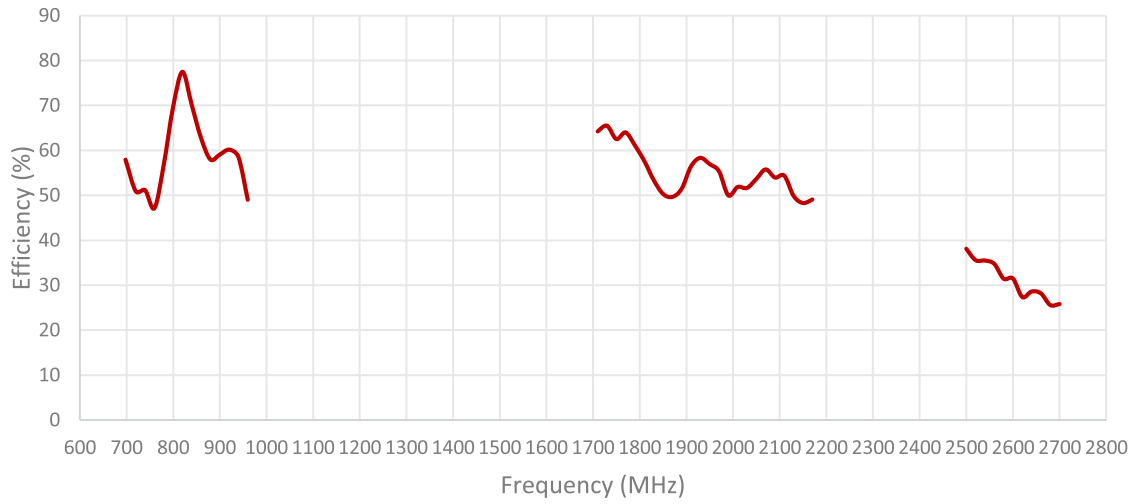

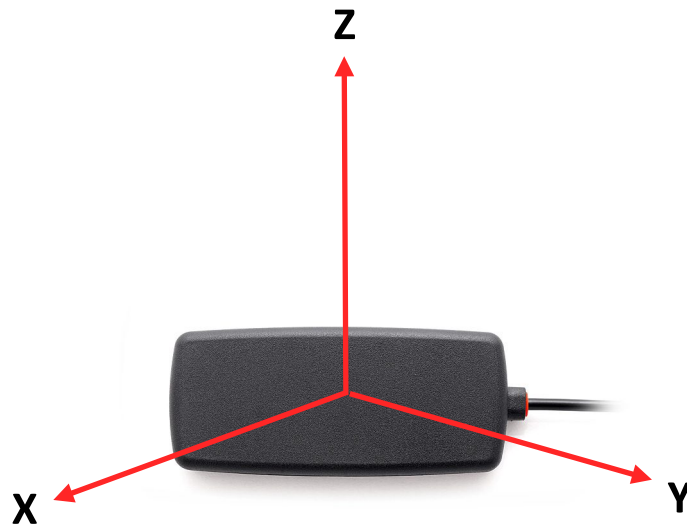
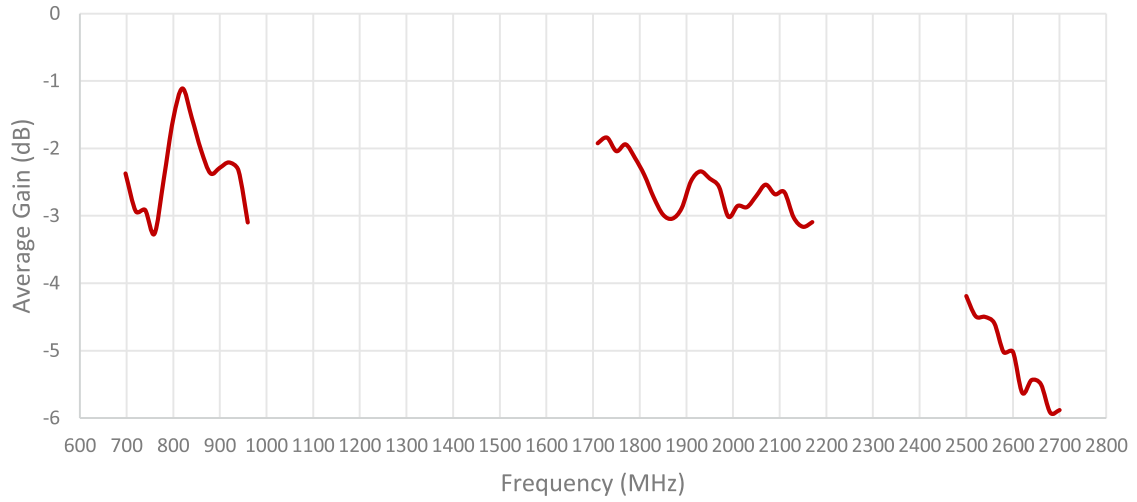

Radiation pattern reference

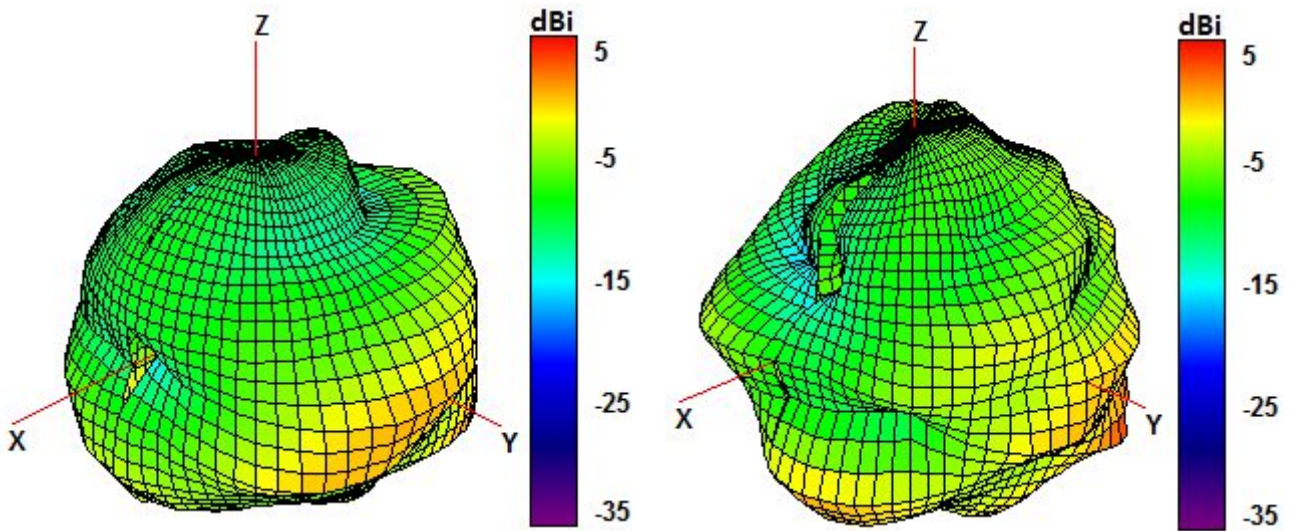

750 and 850 MHz Radiation pattern

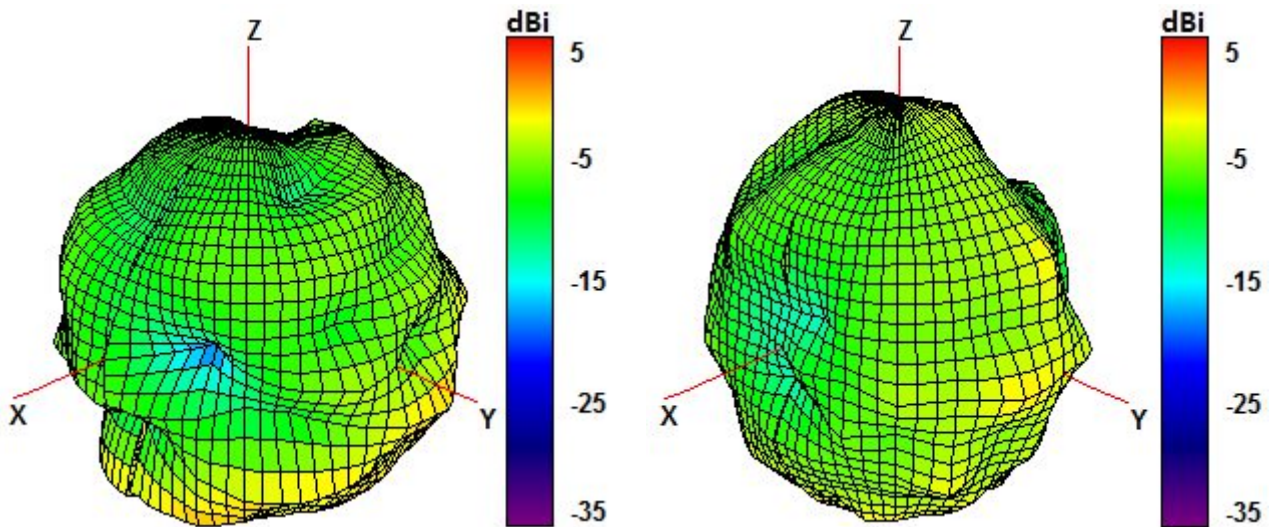

940 and 1750 MHz Radiation pattern

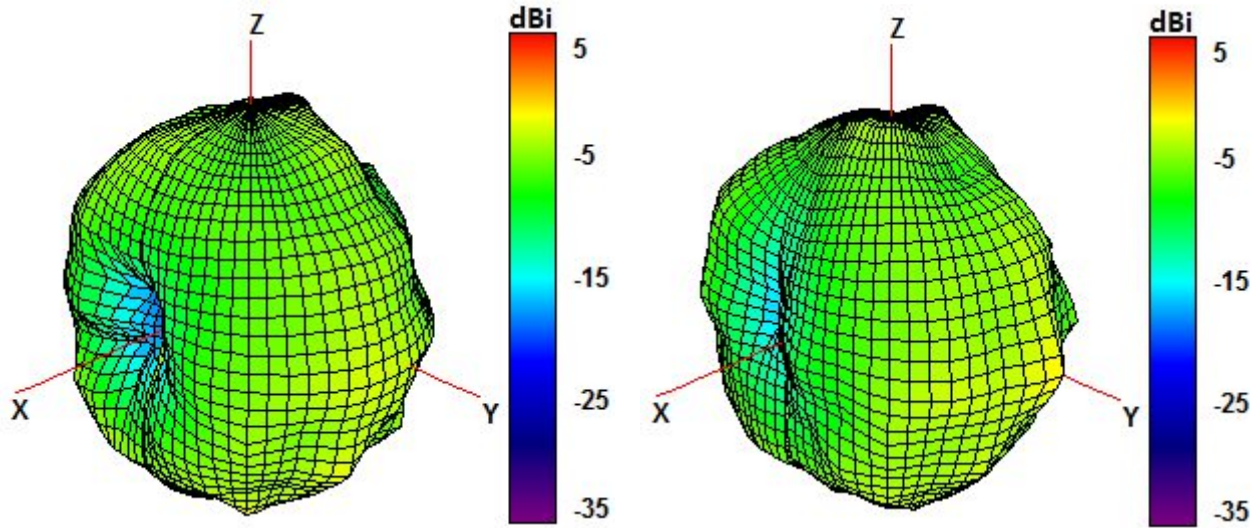

1850 and 1950 MHz Radiation pattern

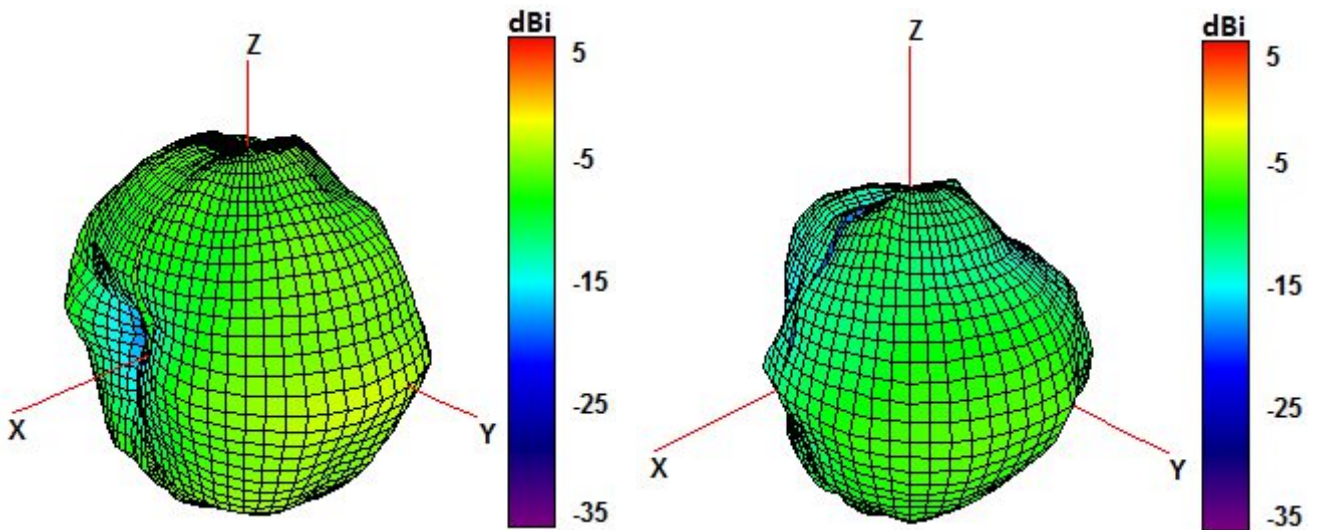

2100 and 2600 MHz Radiation pattern

## 4. Antenna drawings

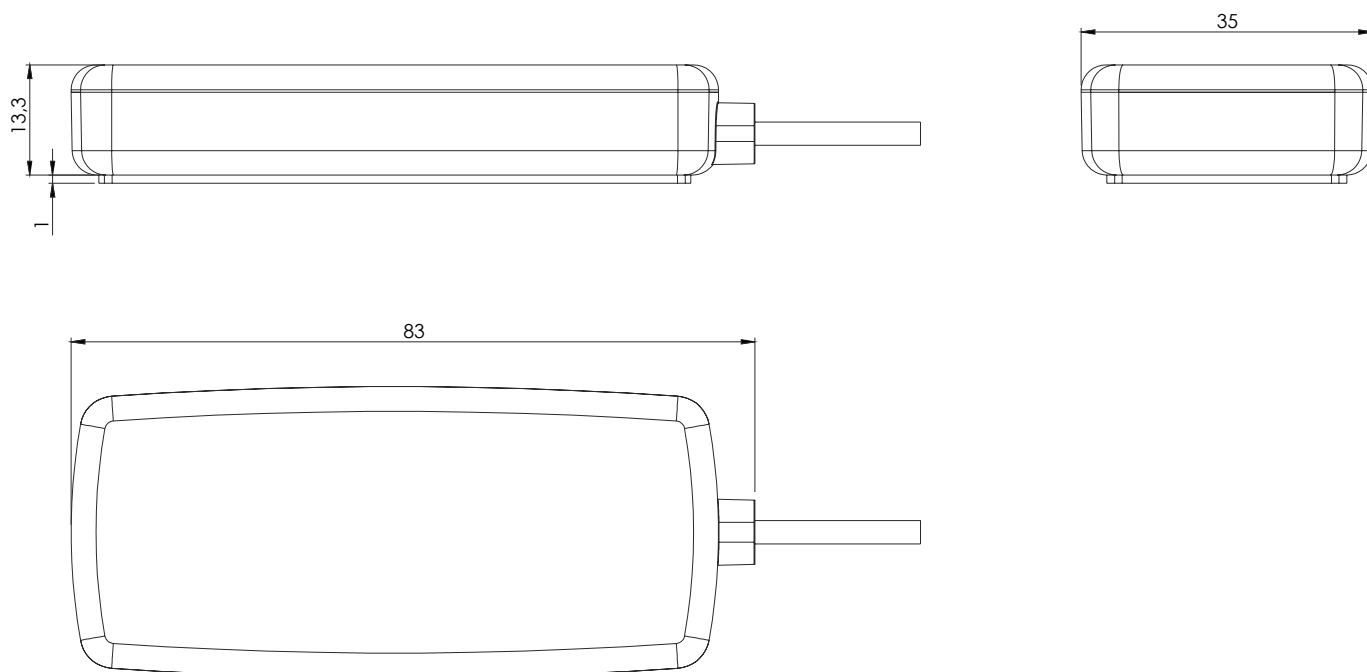



## 5. Antenna Images

