

2J5215P-915

915 MHz ISM Adhesive Mount

Key Features

- 915 MHz ISM
- 902-928 MHz
- Adhesive Mount
- Flexible Housing
- Compact Size
- High Performance
- Customizable Cable and Connector
- Dimensions 117.4 x 12.5 x 6.5 mm



1. Antenna and electrical specifications

Parameters	915 MHz ISM Antenna
Standards	ZigBee, ISM, SigFox, LoRa
Band (MHz)	915 MHz
Frequency (MHz)	902-928
Return Loss (dB)	~-21.2
VSWR	~1.2:1
Efficiency (%)	~59.5
Peak Gain (dBi)	~3.0
Average Gain (dB)	~-2.3
Impedance (Ohm)	50
Polarisation	Linear
Radiation Pattern	Omni-Directional
Max. Input Power (W)	25
Connector Type	SMA-Male Standard (Other Connectors Available)
Cable Length	300 cm Standard (Any Cable Length Available)
Cable Type	RG174 Standard (Other Cables Available)

Antenna Measurement Conditions:

Mounted on 30 x 30 x 0.25 cm ABS Plate

200 cm RG174 Cable

Measured in Certified CTIA 3D Anechoic Chamber

2. Mechanical and environmental specifications

Specifications	2J5215P-915
Mounting Type	Adhesive Mount
Dimensions (mm)	117.4 x 12.5 x 6.5
Radome	TPE
Radome color	Black, White
Operating Temperature (C)	-40 to +85
Storage Temperature (C)	-40 to +85
Substance Compliance	RoHS

3. Antenna parameters

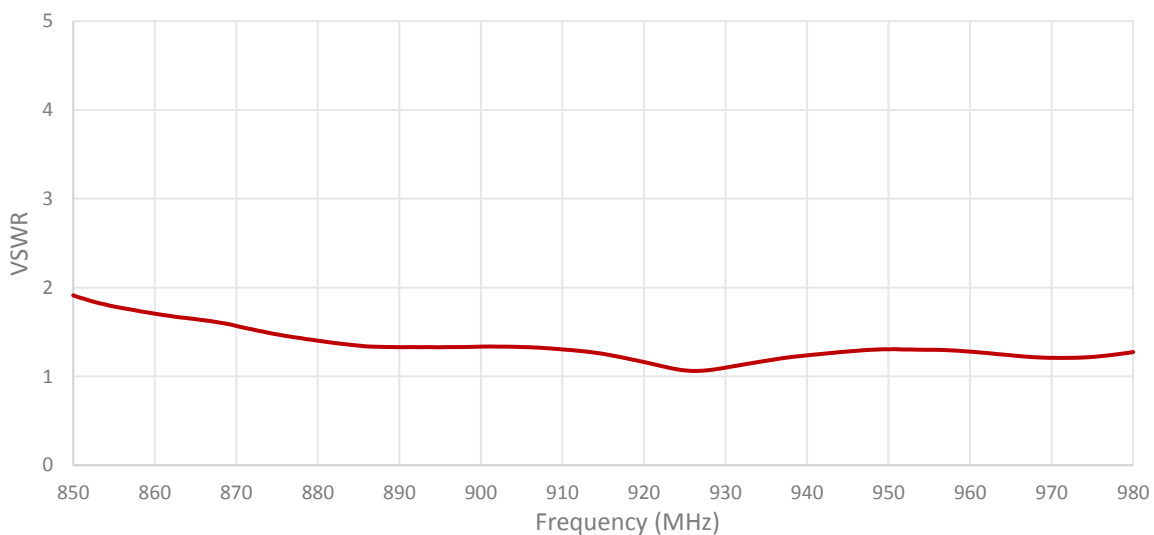
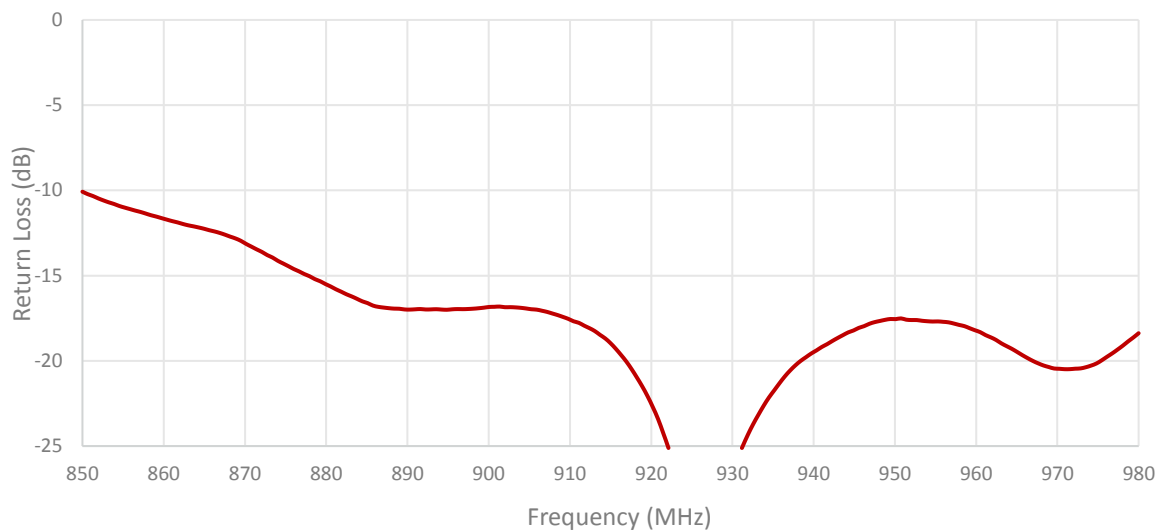

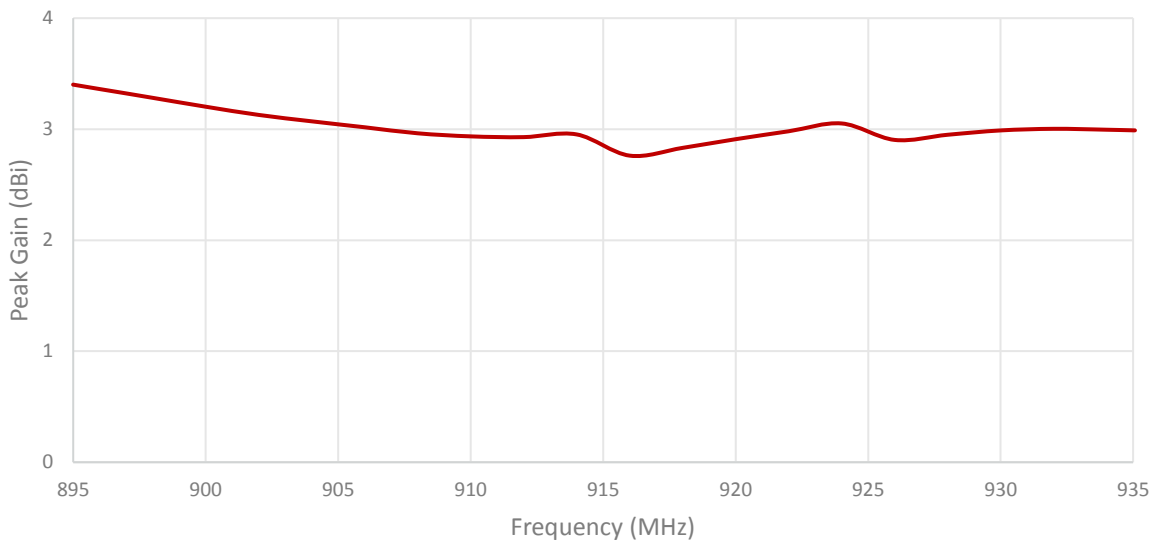
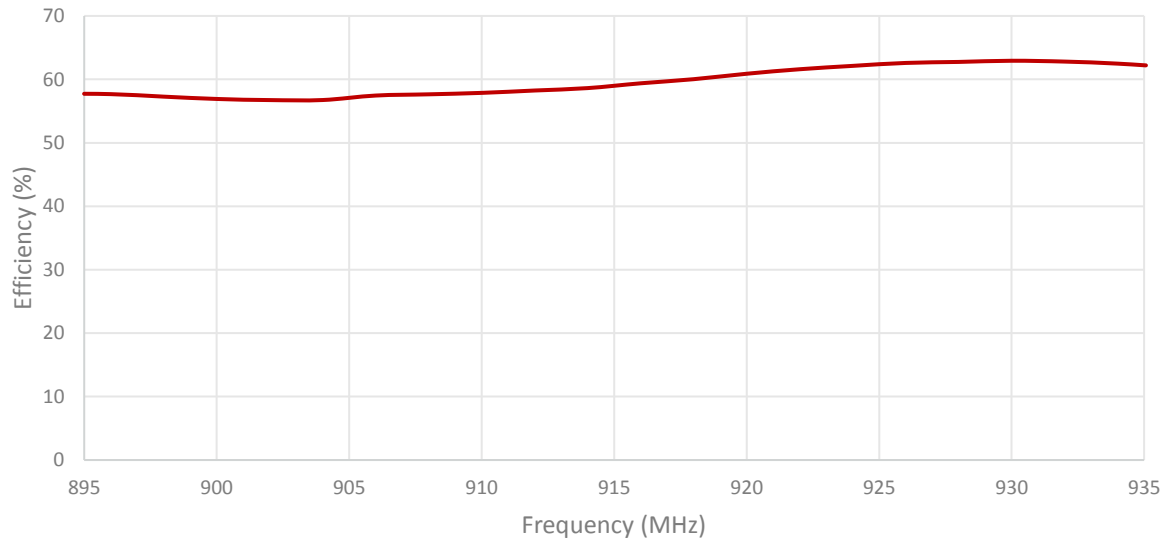

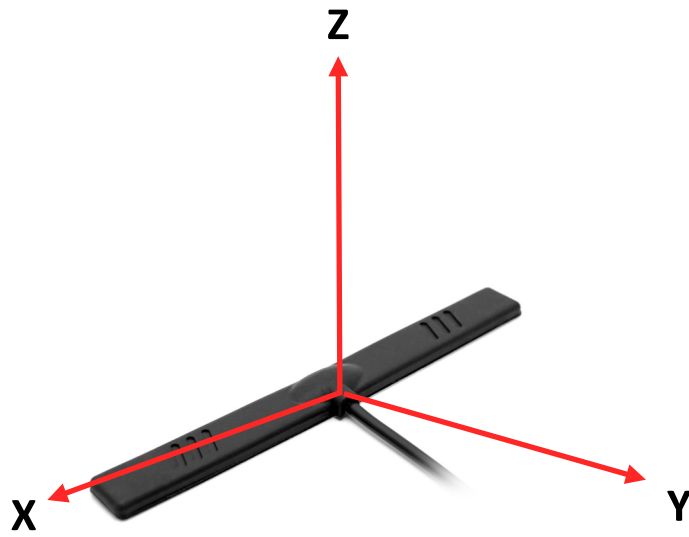
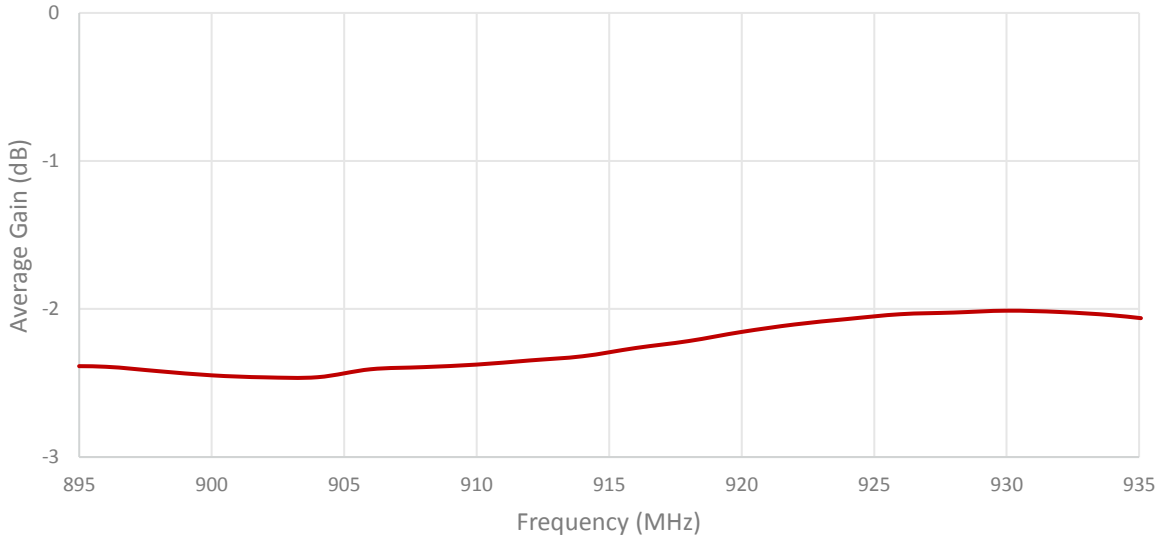

Radiation pattern reference

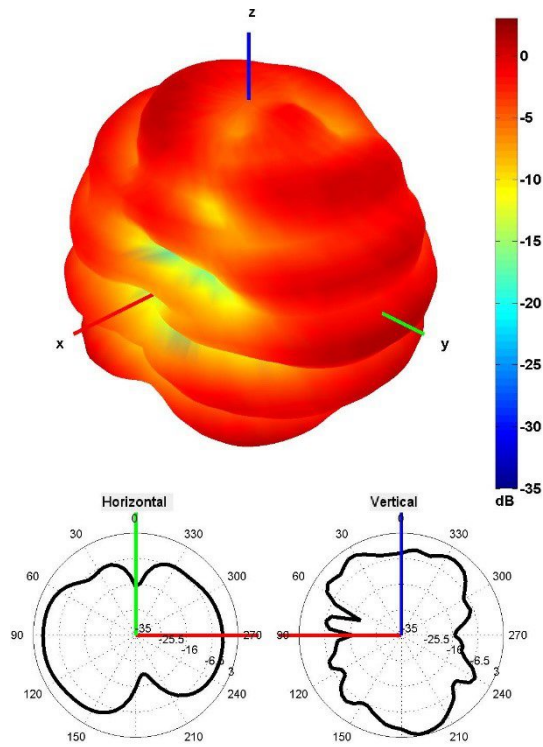

915 MHz Radiation pattern

4. Antenna drawings

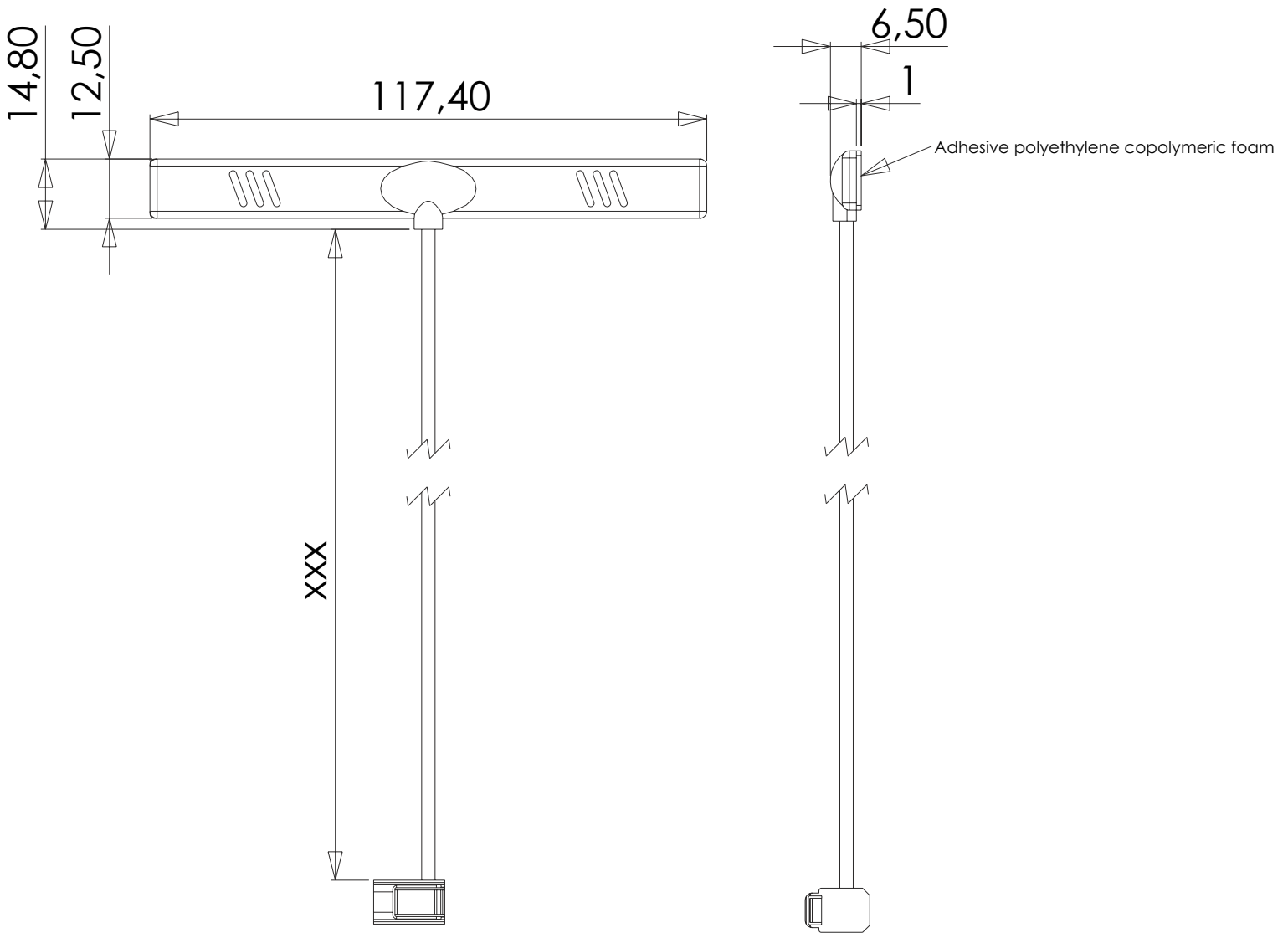

5. Antenna Images

