

● **Features:**

1. Chip material: GaAsP/GaP
2. Emitted color : hi-eff red
3. Lens Appearance : red diffused
4. Low power consumption.
5. High efficiency.
6. Versatile mounting on P.C. Board or panel.
7. Low current requirement.
8. 3mm diameter package.

● **Applications:**

1. TV set
2. Monitor
3. Telephone
4. Computer
5. Circuit board

● **Package dimensions:**

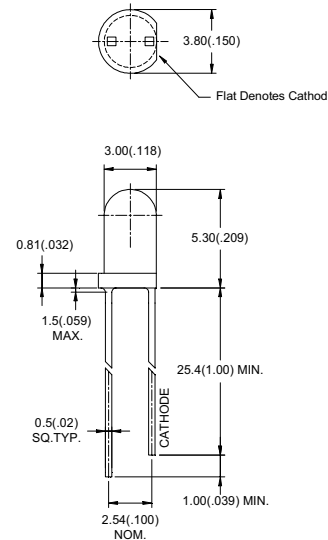

Notes:

1. All dimensions are in millimeters (inches).
2. Tolerance is ± 0.25 mm (0.01") unless otherwise specified.
3. Lead spacing is measured where the leads emerge from the package.
4. Specifications are subject to change without notice.

● **Absolute Maximum Ratings(Ta=25°C)**

Parameter	Symbol	Rating	Unit
Power Dissipation	Pd	80	mW
Forward Current	I _F	30	mA
Peak Forward Current* ¹	I _{FP}	150	mA
Reverse Voltage	V _R	5	V
Operating Temperature	Topr	-40°C~80°C	
Storage Temperature	Tstg	-40°C~85°C	
Soldering Temperature	Tsol	260°C (for 5 seconds)	

*¹Condition for I_{FP} is pulse of 1/10 duty and 0.1msec width.

● Electrical and optical characteristics(Ta=25°C)

Parameter	Symbol	Condition	Min.	Typ.	Max.	Unit
Forward Voltage	V_F	$I_F=20mA$	-	2.0	2.6	V
Luminous Intensity	I_v	$I_F=20mA$	-	40	-	mcd
Reverse Current	I_R	$V_R=5V$	-	-	100	μA
Peak Wave Length	λ_p	$I_F=20mA$	-	640	-	nm
Dominant Wave Length	λ_d	$I_F=20mA$	617	-	638	nm
Spectral Line Half-width	$\Delta \lambda$	$I_F=20mA$	-	40	-	nm
Viewing Angle	$2\theta_{1/2}$	$I_F=20mA$	-	35	-	deg

● Typical Electro-Optical Characteristics Curves

Fig.1 Relative intensity vs. Wavelength

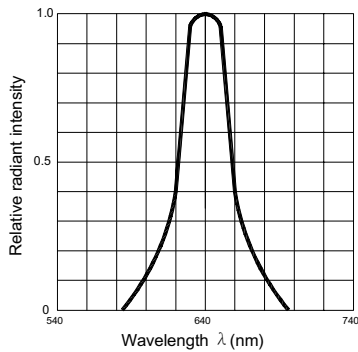

Fig.2 Forward current derating curve vs. Ambient temperature

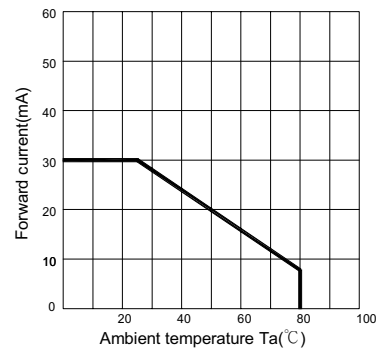

Fig.3 Forward current vs. Forward voltage

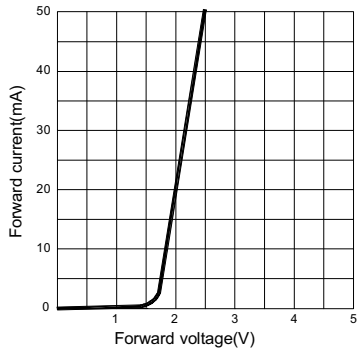

Fig.4 Relative luminous intensity vs. Ambient temperature

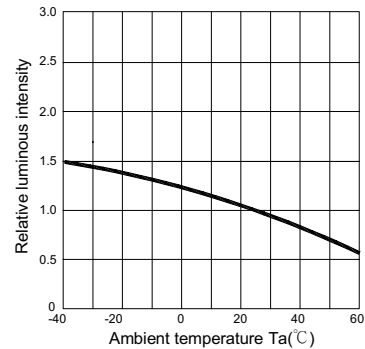

Fig.5 Relative luminous intensity vs. Forward current

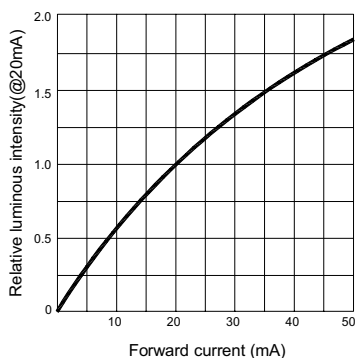
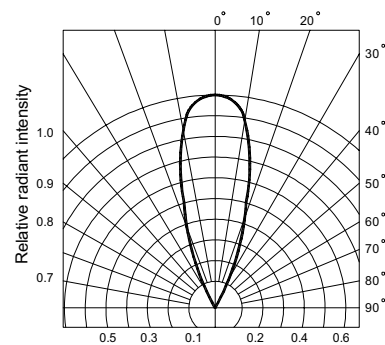

Fig.6 Radiation diagram



● **Bin Limits**

1. Intensity Bin Limits (At $I_F = 20\text{mA}$)

Bin Code	Min. (mcd)	Max. (mcd)
:	:	:
K	11	21
L	16	32
M	24	48
N	37	72
P	55	110
:	:	:

● Bin : x

